

WATER JET CUTTING

mvt AG offers a comprehensive, economically-priced range of sapphire nozzles for the most varied of applications in the field of water jet cutting. All of our nozzles consist of a stainless steel nozzle body with a sapphire orifice. Their special design gives them a high degree of stability and safety. Special designs and customer-specific solutions are available on request.

PROPERTIES AND ADVANTAGES

- ▶ Long lifetime
- ▶ Consistent jet quality
- ▶ Precision cutting accuracy
- ▶ Narrow cut width
- ▶ High cutting performance
- ▶ Longer lifetime of focusing tube
- ▶ Excellent price-to-performance ratio
- ▶ Swiss quality

CUSTOMER BENEFITS

- ▶ High productivity
- ▶ Minimal downtime
- ▶ Cost-effective manufacturing
- ▶ High quality standard
- ▶ Expert advice
- ▶ Reliable service

APPLICATIONS

- ▶ Clear water: paper, carton, corrugated cardboard, wood, plastics, foodstuffs, baked goods, frozen foods, meat, fish, composites, automotive parts such as carpets, door panels, dashboards, shock absorbers, instrument panels, parcel shelves, etc.
- ▶ Abrasive: metal, titanium, aluminium, stone, marble, granite, ceramics, reinforced concrete, plaster, rock wool, laminated glass, safety glass, bullet-proof glass, wood, plastics, composites, automotive and aircraft parts, etc

Sapphire nozzle Type 265

Max. 4000 bar

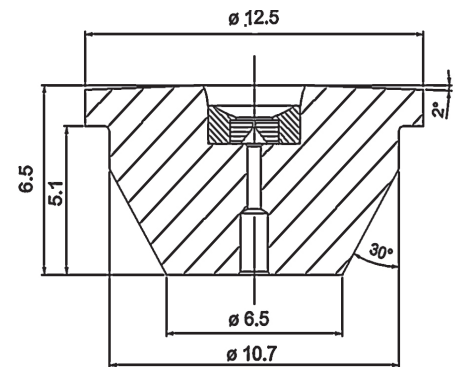

DESCRIPTION

- R = Pure waterjet cutting nozzles, aiming accuracy 100% tested
- RX = Pure waterjet cutting nozzles, aiming accuracy not tested
- P = Polymer cutting nozzles, aiming accuracy 100% tested
- PX = Polymer cutting nozzles, aiming accuracy not tested
- A = Abrasive cutting nozzles, aiming accuracy 100% tested
- AX = Abrasive cutting nozzles, aiming accuracy not tested

ON REQUEST THE AIMING ACCURACY OF NOZZLES CAN BE TESTED ACCORDING TO THE FOLLOWING CRITERIA

- The distance from the nozzle to the target mark is 100 mm
- The target mark has a Ø of 0.50 mm in the case of nozzles with a Ø of up to 0.20 mm
- The target mark has a Ø of 0.80 mm in the case of nozzles with a Ø of > 0.20 mm
- The target mark has a Ø of 1.10 mm in the case of nozzles with a Ø of > 0.30 mm
- The test pressure is 50 bar
- 100% testing is only carried out if requested by the customer

PERFORMANCE

Water density at 20° C	2500 bar	Jet force	Jet speed
	kg/m ³ 1085.68		
Nozzles Ø mm	l/min	N	m/sec
0.08	0.139	1.6	707
0.10	0.217	2.6	707
0.12	0.313	3.7	707
0.15	0.489	5.8	707
0.17	0.628	7.4	707
0.20	0.870	10.3	707
0.25	1.359	16.1	707
0.30	1.957	23.1	707
0.35	2.664	31.5	707
0.40	3.479	41.1	707
0.45	4.403	52.0	707

Water density at 20° C	3000 bar	Jet force	Jet speed
	kg/m ³ 1100.30		
Nozzles Ø mm	l/min	N	m/sec
0.08	0.151	2.0	775
0.10	0.237	3.1	775
0.12	0.341	4.4	775
0.15	0.532	6.9	775
0.17	0.684	8.9	775
0.20	0.946	12.3	775
0.25	1.479	19.1	775
0.30	2.130	27.6	775
0.35	2.899	37.5	775
0.40	3.786	49.0	775
0.45	4.792	62.0	775

Water density at 20° C	3500 bar	Jet force	Jet speed
	kg/m ³ 1114.28		
Nozzles Ø mm	l/min	N	m/sec
0.08	0.163	2.3	837
0.10	0.254	3.6	837
0.12	0.366	5.1	837
0.15	0.571	8.0	837
0.17	0.734	10.3	837
0.20	1.016	14.2	837
0.25	1.587	22.2	837
0.30	2.286	32.0	837
0.35	3.111	43.5	837
0.40	4.064	56.8	837
0.45	5.143	71.9	837

Water density at 20° C	4000 bar	Jet force	Jet speed
	kg/m ³ 1127.60		
Nozzles Ø mm	l/min	N	m/sec
0.08	0.173	2.6	894
0.10	0.270	4.0	894
0.12	0.389	5.8	894
0.15	0.607	9.1	894
0.17	0.780	11.7	894
0.20	1.080	16.1	894
0.25	1.687	25.2	894
0.30	2.429	36.3	894
0.35	3.306	49.4	894
0.40	4.318	64.6	894
0.45	5.465	81.7	894